

MISUTONIDA
italian style accessories **4x4**

JEEP COMPASS



Item Code

Codice Articolo

Référence Article

: ***P/205/IX***

GB

**STAINLESS STEEL
SIDESTEPS**

ITA















**PEDANE SOTTOPORTA
IN ACCIAIO INOX**

FR

**MARCHEPIEDS
EN ACCIER INOX**

JEEP COMPASS

Part List
 Lista della bulloneria
 Liste des pièces

A	 TE 10X50 x 4	M	 S/205A/DX x 1
B	 M 10 autoblocking autobloccante autobloquante x 4	N	 S/205A/SX x 1
C	 CAV 181 x 2	O	 S/205P/DX x 1
D	 M 8 x 4	P	 S/205P/SX x 1
E	 Ø 8 x 4		
F	 Ø 8 x 4		
G	 P/48 x 2		
H	 Ø 10 x 2		
I	 Ø 10 x 2		
L	 M 10 x 2		

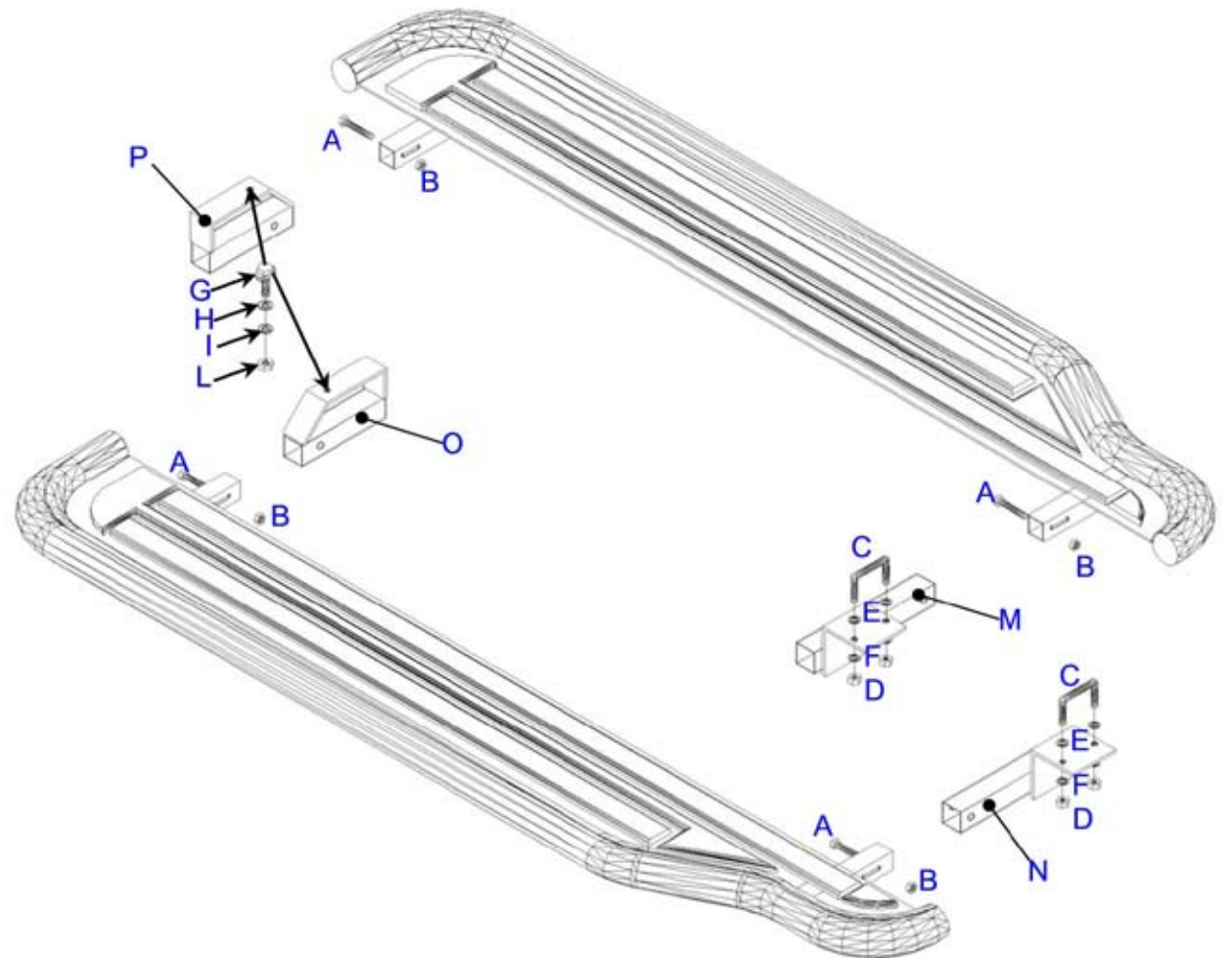

 **MISUTONIDA**
  *italian style* **4x4**
 accessories

GB

FITTING INSTRUCTIONS

FRONT SIDE

1. Insert **C** in the holes shown in picture 1 and make it come out as shown in picture 2.
2. Fit **N** and **M** on **C** using **E,F,D** (picture 3).

REAR SIDE

3. Insert **G** in the hole shown in picture 4 and make it come out as shown in picture 5.
4. Fit **P** and **O** as shown in picture 6 using **H,I,L**.
5. Tighten all the set of bolts.

ITA

ISTRUZIONI DI MONTAGGIO

PARTE ANTERIORE

1. Inserire **C** nei fori indicati in foto 1 e farla fuoriuscire come indicato in foto 2.
2. Montare i supporti **N** e **M** sulle cavallette appena montate utilizzando **E,F,D** foto 3.

PARTE POSTERIORE

3. Inserire **G** nel foro indicato in foto 4 e farlo fuoriuscire come indicato in foto 5.
4. Fissare i supporti **P** e **O** come indicato in foto 6 utilizzando **H,I,L**.
5. Serrare tutta la bulloneria.

FR

INSTRUCTIONS DE MONTAGE

PARTIE ANTERIEURE

1. *Insérer **C** dans les trous indiqués dans la photo 1 et les faire sortir comme indiqué dans la photo 2.*
2. *Monter **N** et **M** sûr **C** en utilisant **E,F,D** (photo 3)*

PARTIE POSTERIEURE

3. *Insérer **G** dans le trou indiqué dans la photo 4 et le faire sortir comme indiqué dans la photo 5.*
4. *Fixer **P** et **O** comme indiqué dans la photo 6 en utilisant **H,I,L**.*
5. *Serrer toute la boulonnerie.*

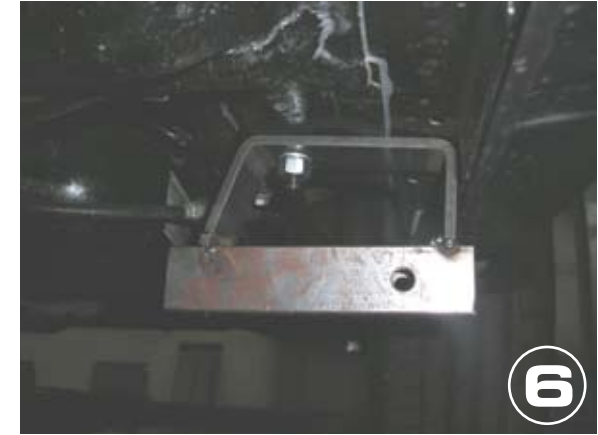

Date Data Date	Item Code Cod.Articolo Réf. Article	Vehicle model Modello Veicolo Modèle de Voiture
28/06/07	P/205/IX	JEEP COMPASS

Checked and approved by
Controllato ed approvato da
Controlé et approuvé par

Botta
Pietro

MISUTONIDA
 italian style
 accessories **4x4**